

Inspection of stainless steel heat exchanger tube with eddy current array probe



12th EPRI Balance-of-Plant Symposium
August 6th-8th, 2012



Introduction

- Context
- Eddy Current Array + Bobbin probe design
 - Overview
 - Operating principle
- Result on various calibration defects
- Comparison with low resolution array probe
- Results on real tube
- Conclusions



Context

- Non ferrous heat exchanger and condenser tubes may be affected by several damage mechanisms:
 - Pitting
 - Erosion
 - Fretting
 - Cracking
- The bobbin probe inspection faces major limitations with respect to:
 - Detection and sizing circumferential cracking
 - Evaluate circumferential extent of volumetric flaws
- Rotating probe can be use to improve the inspection but this solution remains slow
- The Eddy Current Array + Bobbin probe technology is the solution to perform high resolution inspection at the bobbin speed in a single pass.



DefHi™ Probe¹

- One-Pass “Combination” Bobbin plus Array Probe
 - Bobbin probe
 - High resolution oval-coil array ¹
 - Centering devices

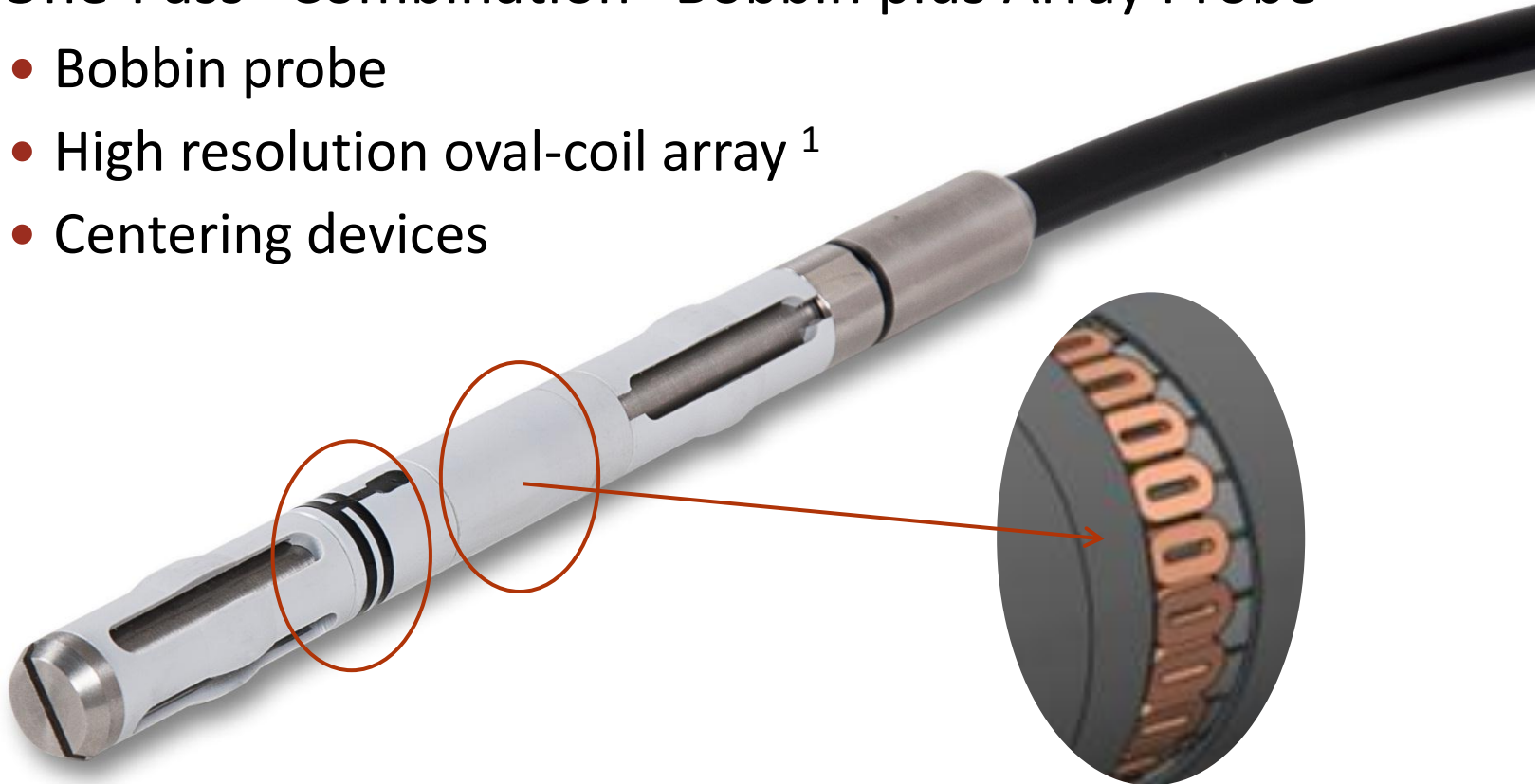

¹ US Patent Pending - Eddyfi NDT Inc.



Operating mode

- Oval-coils array + Bobbin
 - 12 transmitter
 - 12 receivers
 - 2 bobbins
 - Excitation pattern
 - 2 poles
 - 2 skip coils
 - 6 time slots for the array
 - 1 time slot for the bobbin

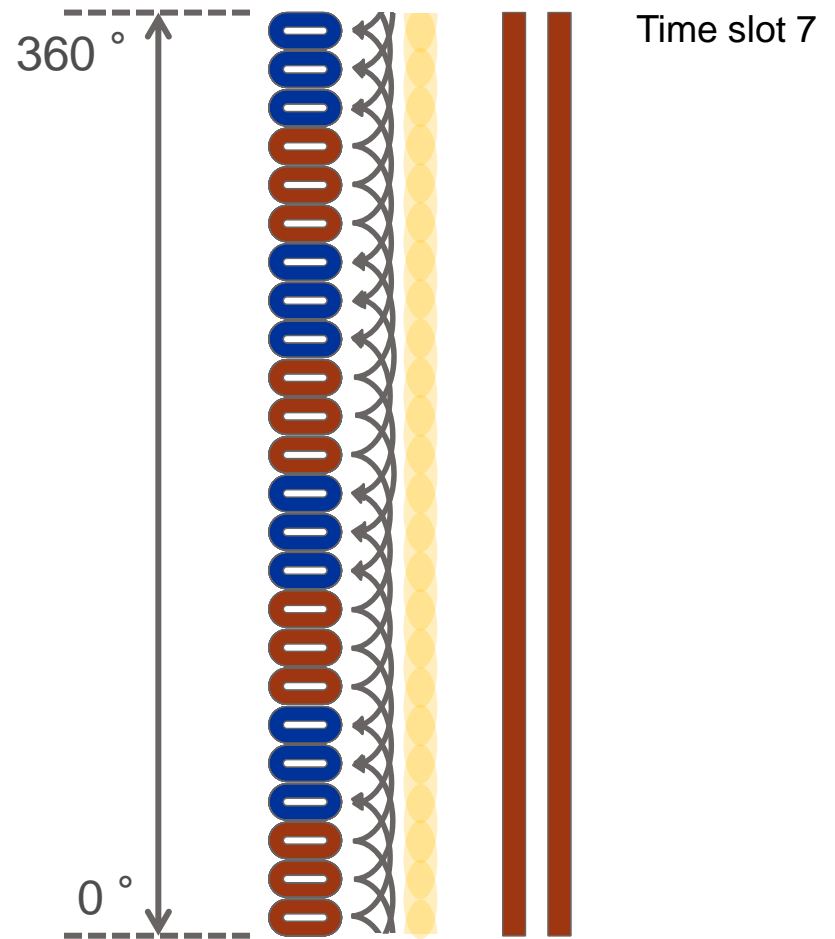



Results for ASME standard

- Calibration on the ID groove
- OD Pits detected on at least 2 channels
- Sizing based on phase to depth curve.

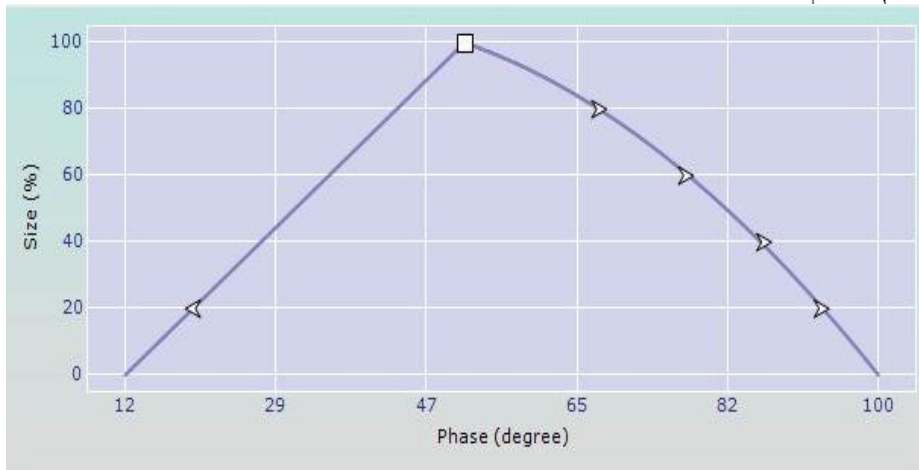
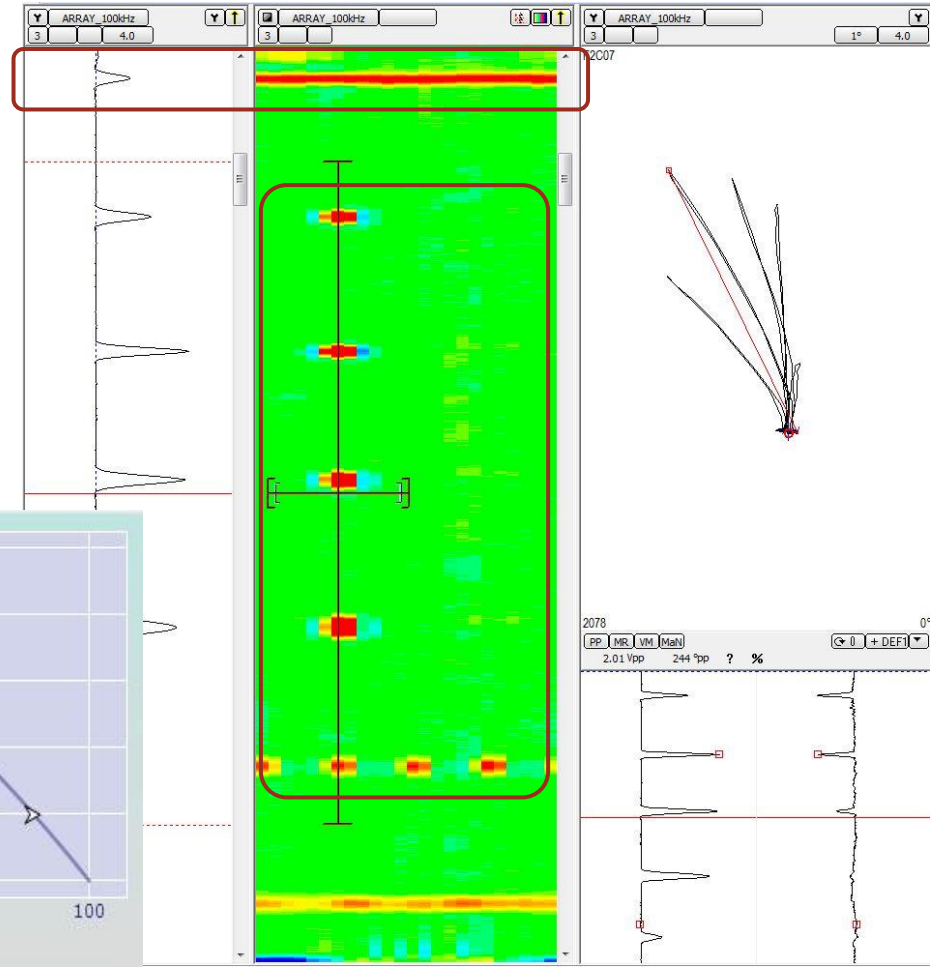



Circumferential Cracks

- Detection of external ED notch (0.005" width)
 - 80% x 50°
 - 60% x 50°
 - 40% x 50°
 - 40% x 25°
 - 20% x 50°
- Bobbin results for the same defects

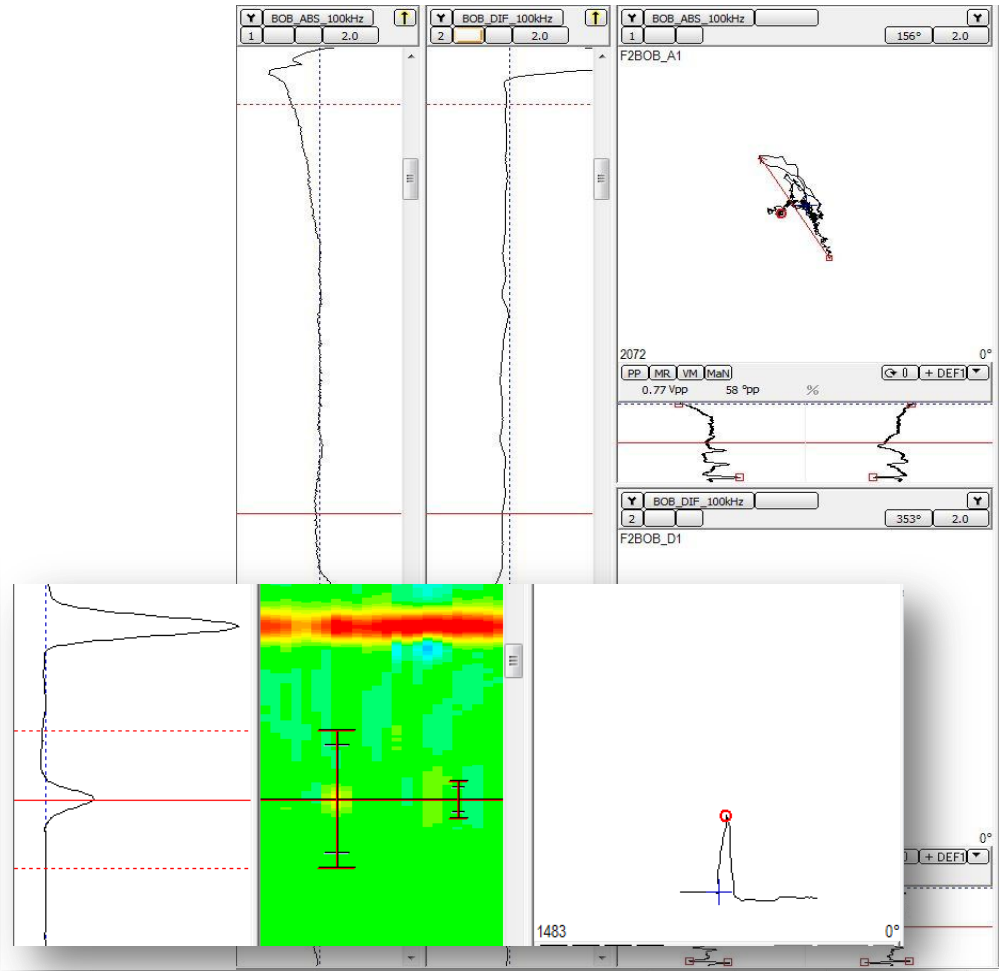



Taper Defects

- Since the probe provides an absolute signal, it is possible to see a representative profile of the defect.

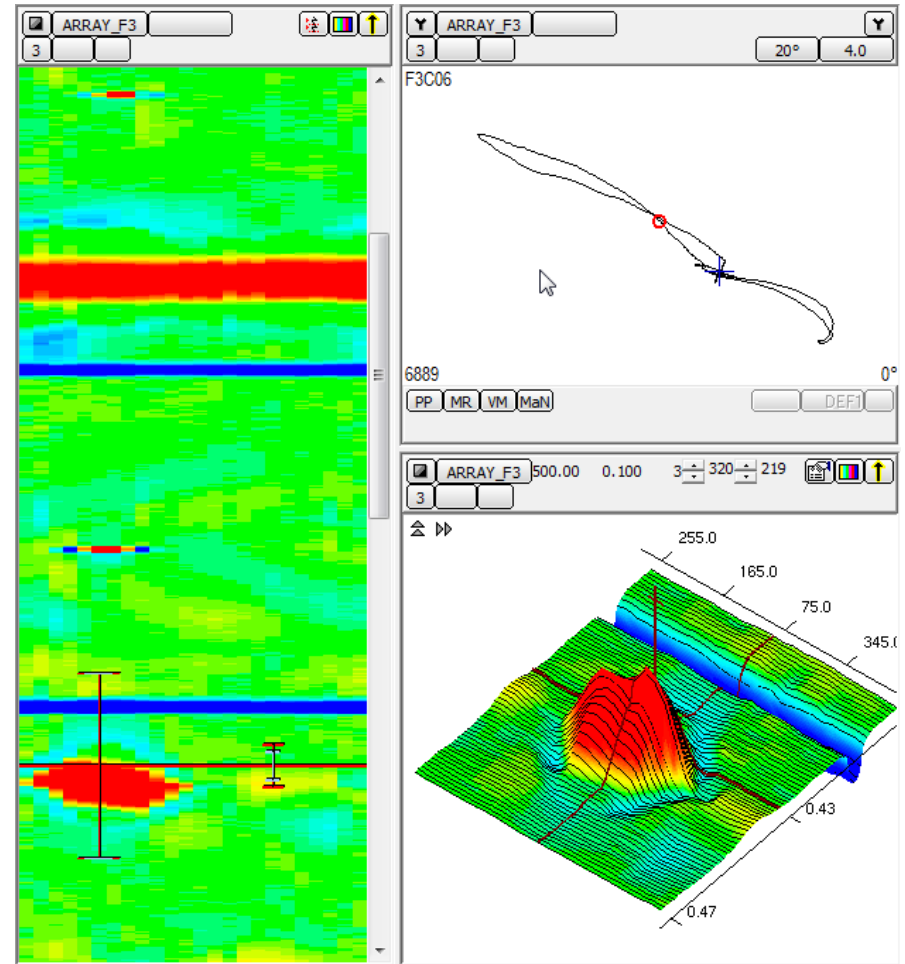



Shallow Small Defects

- The high resolution of the probe allows a better detection of small isolated pit
 - 20% ID round bottom hole, 0.125" diameter
 - 20% OD flat bottom hole, 0.125" diameter

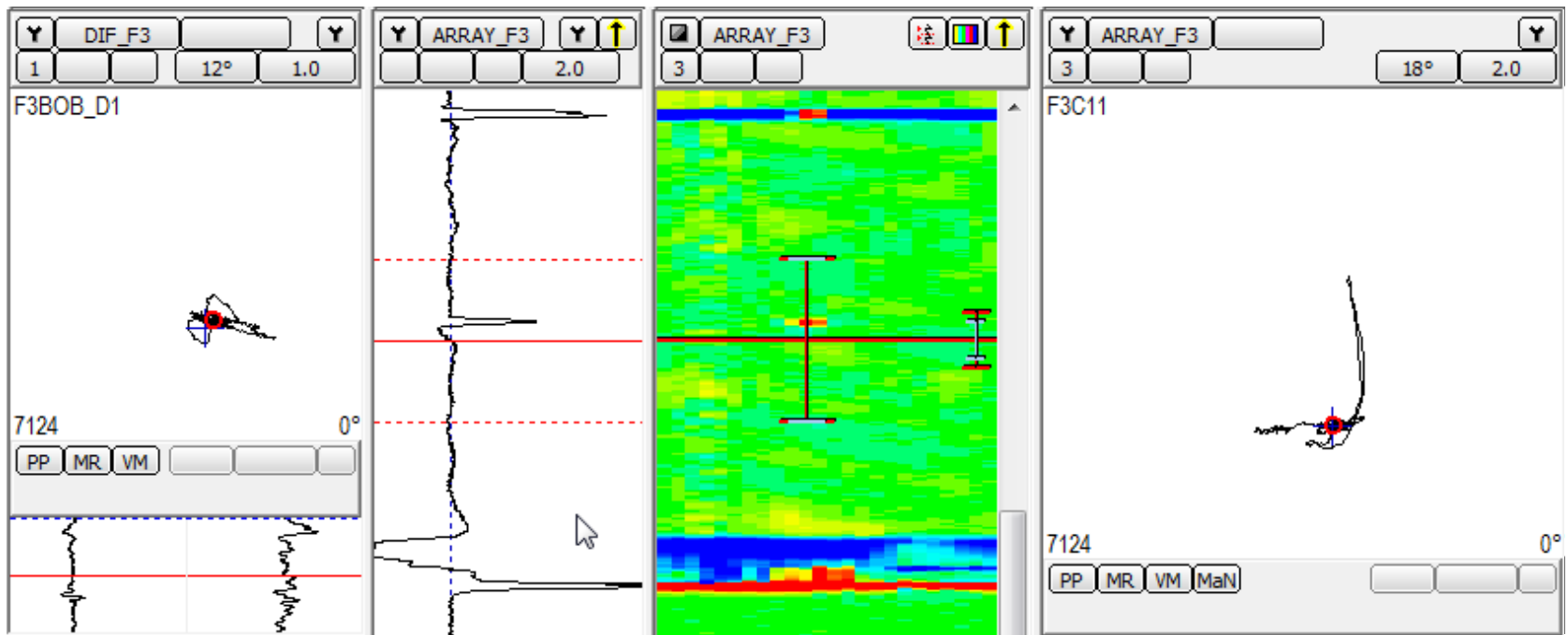



Defects at Support Plate

- Wear scars
 - 60%, extent: 270°
 - 20%, extent: 270°
- OD pits
 - 80%, diam.: 0.375"
 - 30%, diam.: 0.312"
- Circumferential crack
 - 60%, extent: 50°

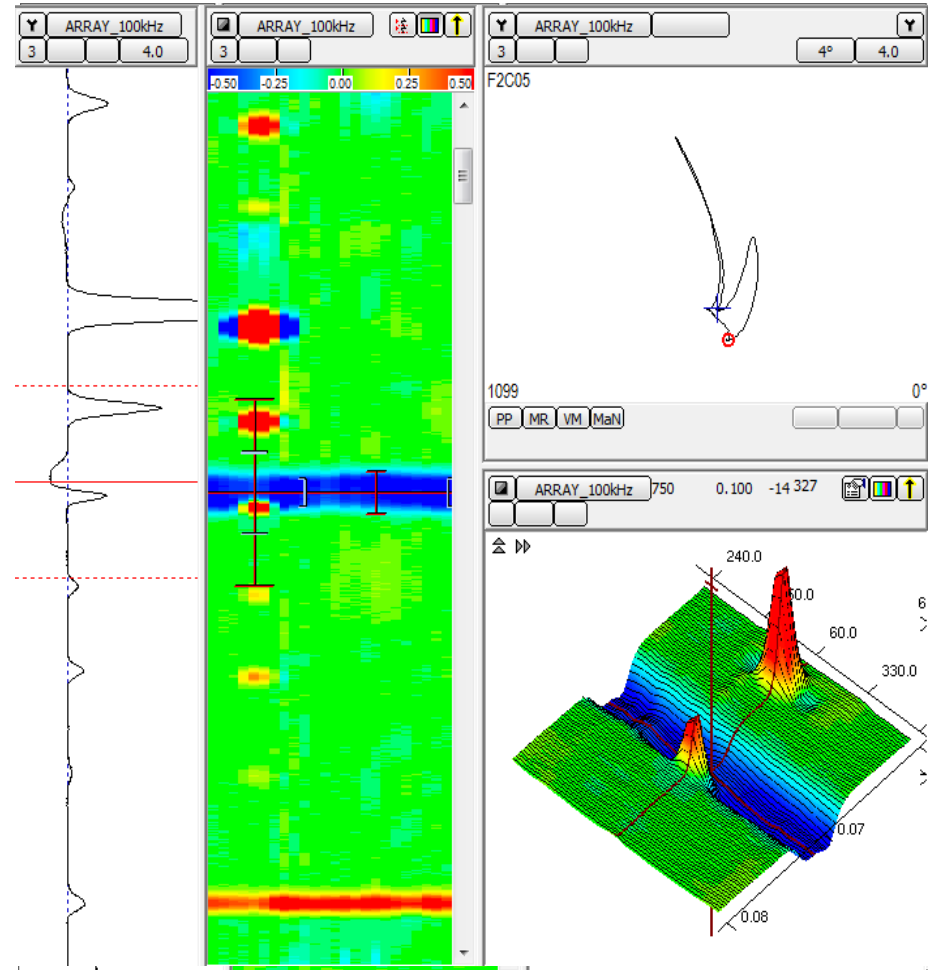



Sensitivity vs Lift-Off

- Defect phase angle is constant even with high lift-off variation providing reliable depth sizing.

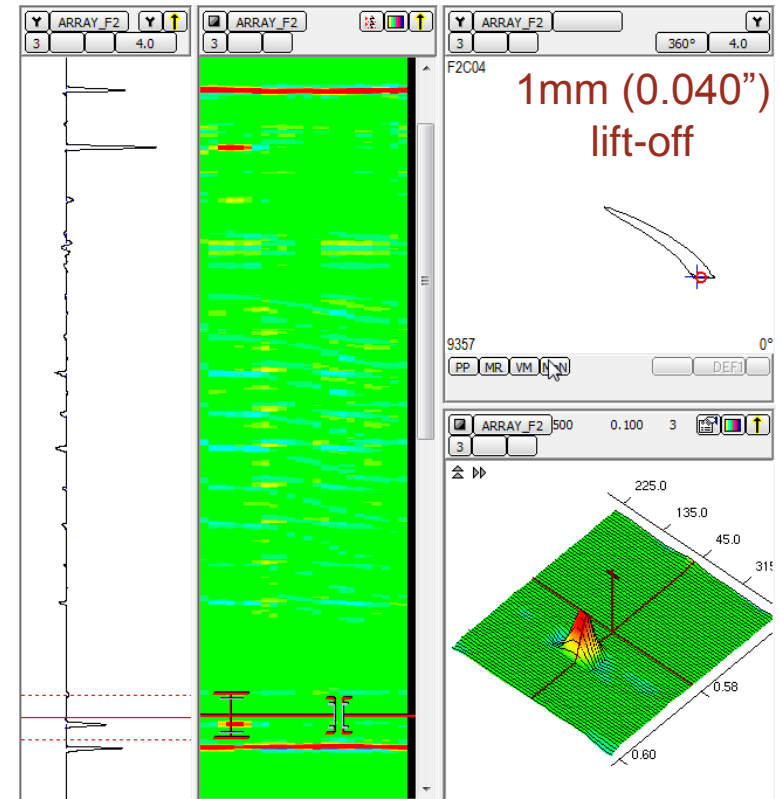
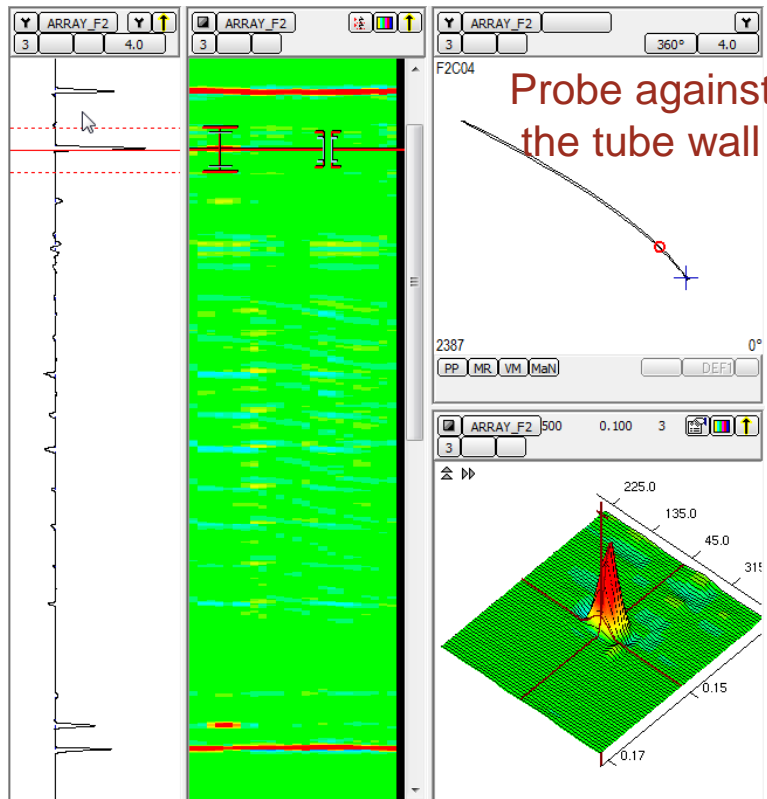



High Resolution Value

- Reliable and repeatable detection
ASME hole scanned 3 times with 15° rotation

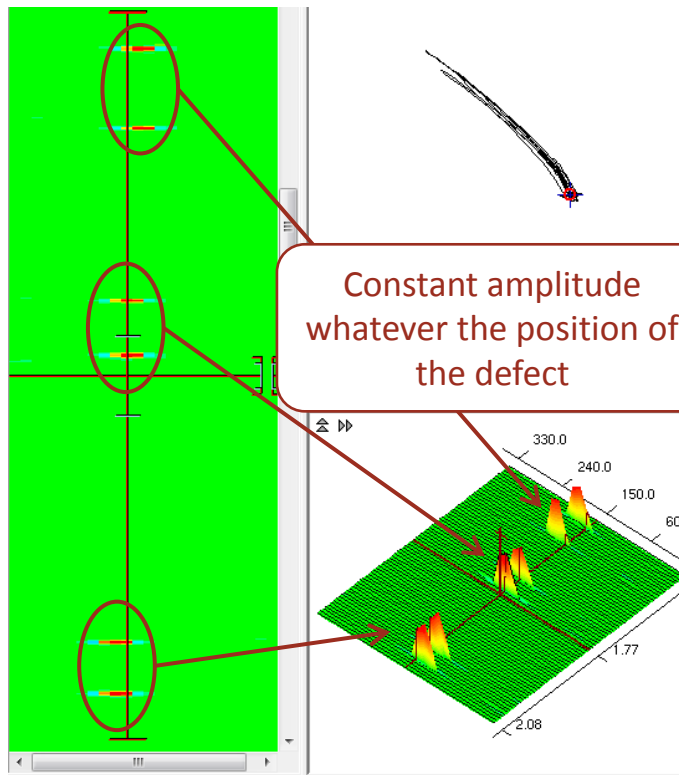

DefHi probe with 24 channels

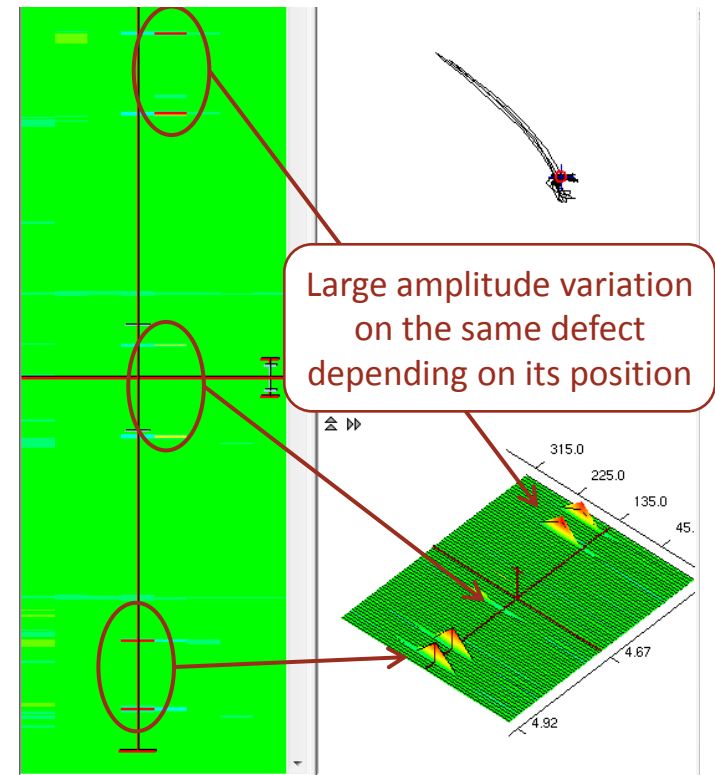

8 channels array



High Resolution Value

- Improved defect representation in C-scan

ASME 40% FBH and 4 x 20% FBH

Several coils see the defects providing uniform response

Only one coil can see the defects resulting in non uniform signature.

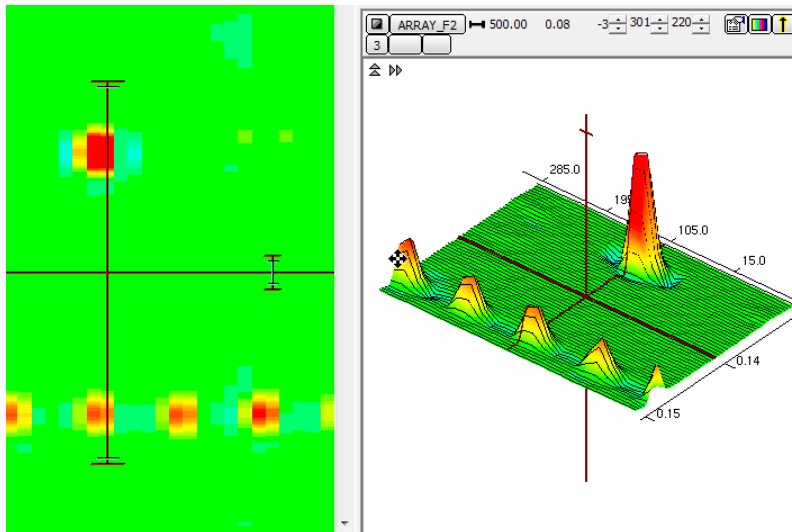

DefHi probe with 24 channels

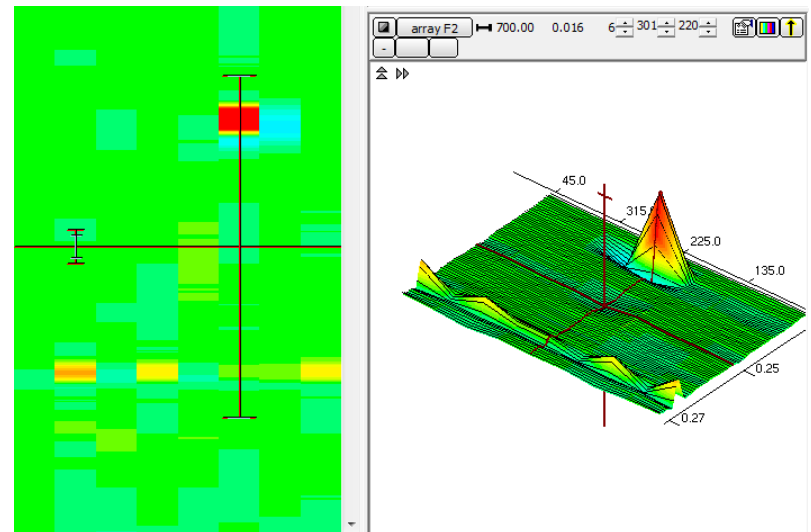

8 channels array



Data from real tube

- Deep OD defect, large volume

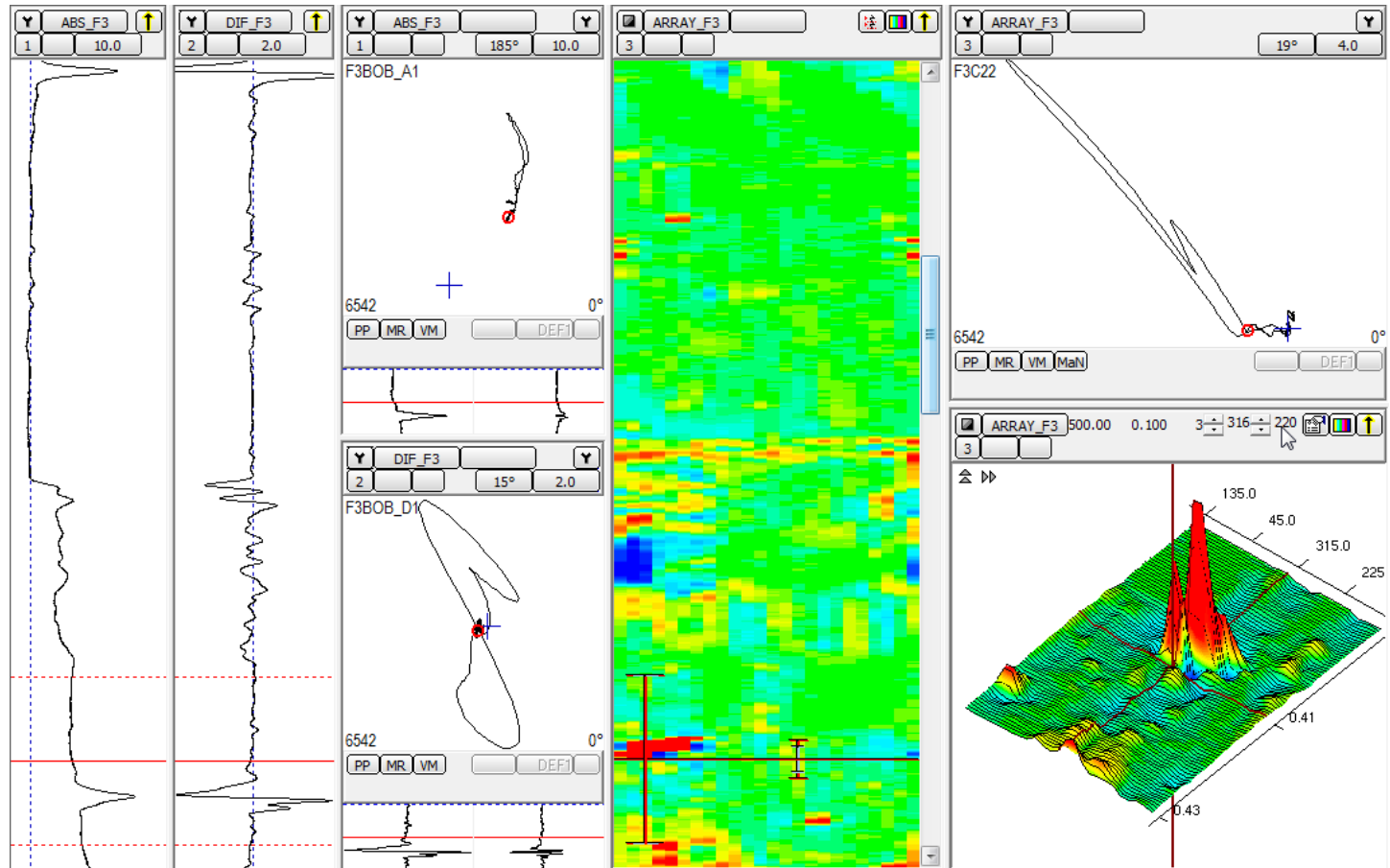



Data from real tube

- Shallow isolated OD pits

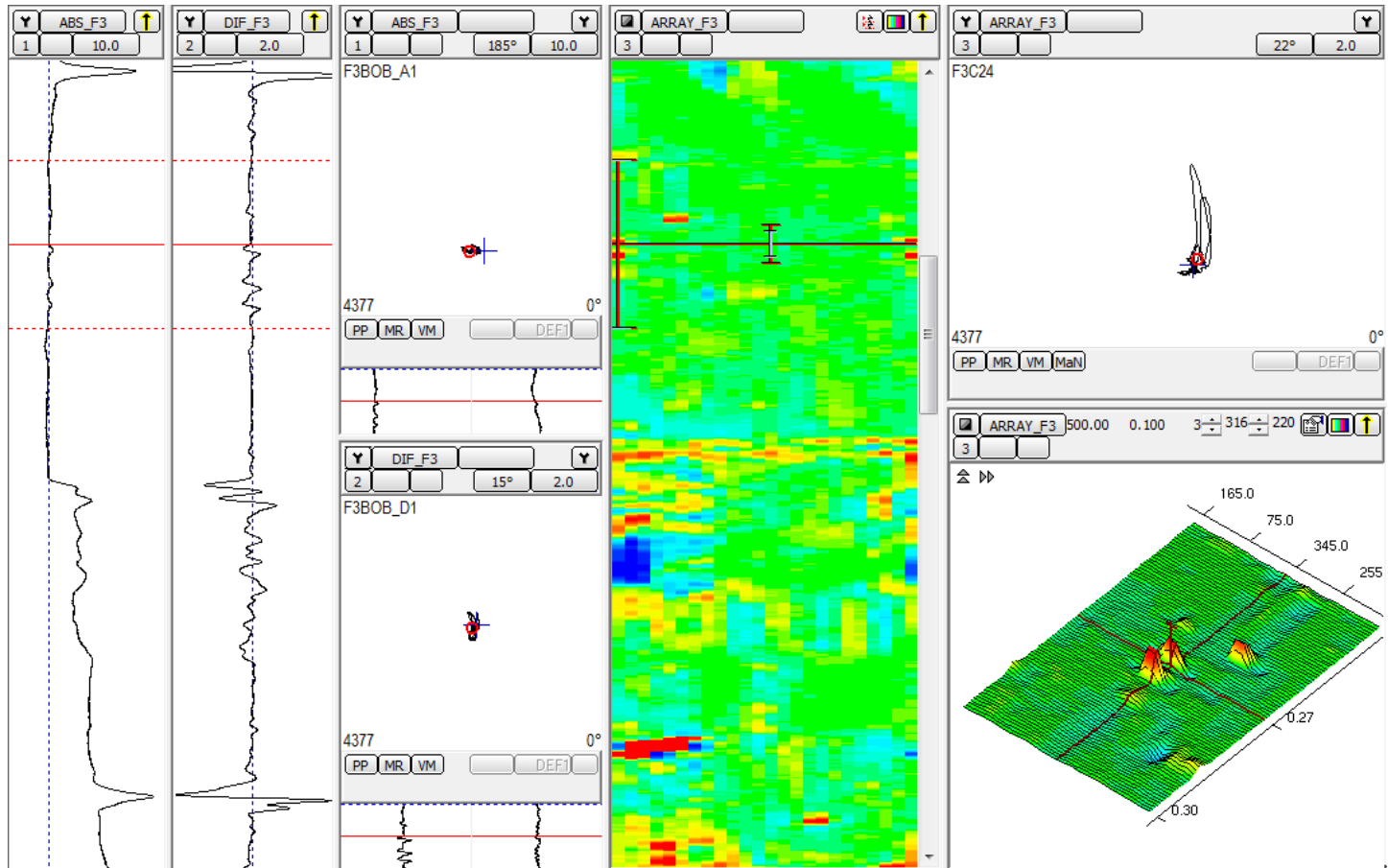



Data from real tube

- OD general corrosion

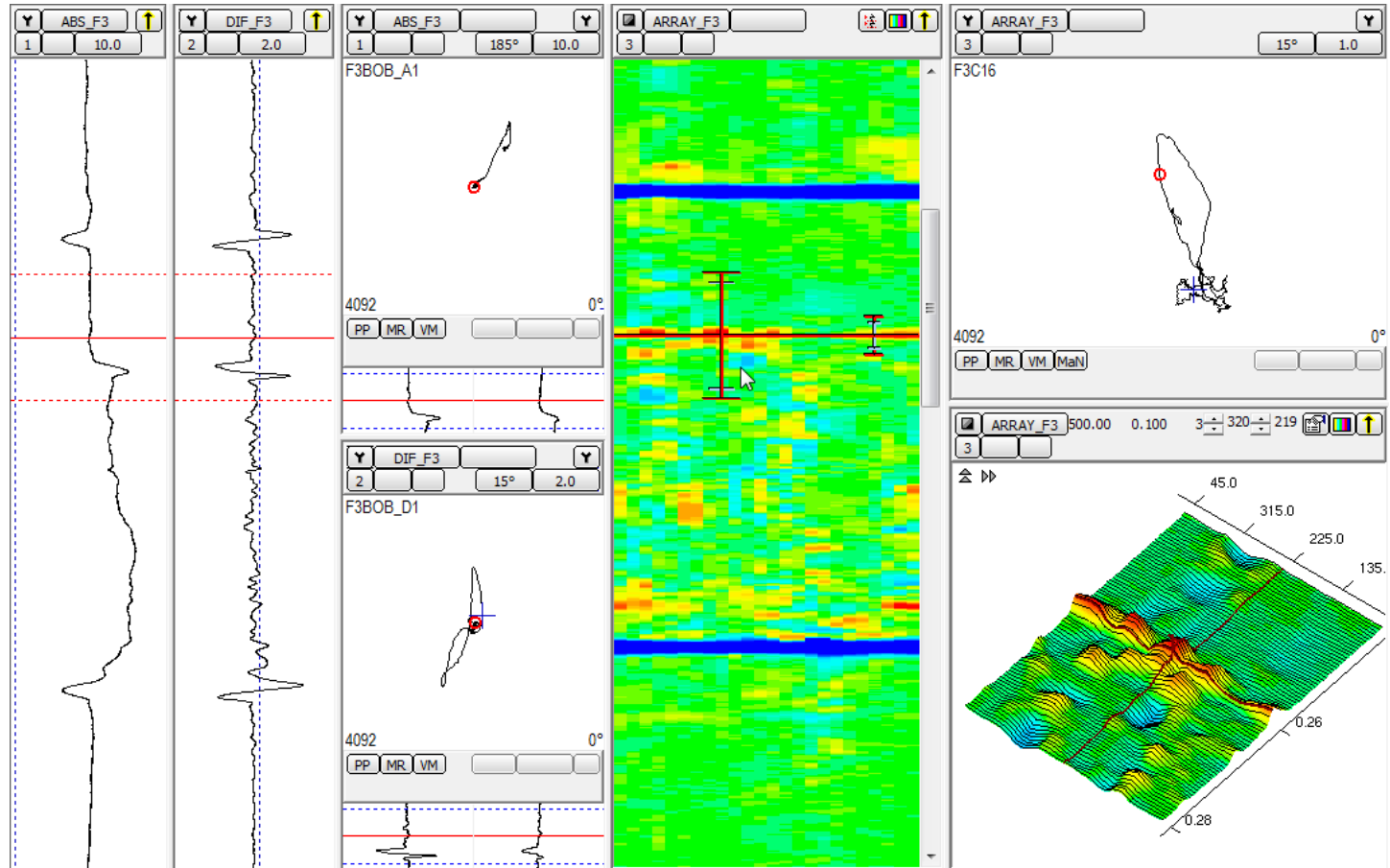



Data from real tube

- OD Pit close to the TSP not detected with the bobbin

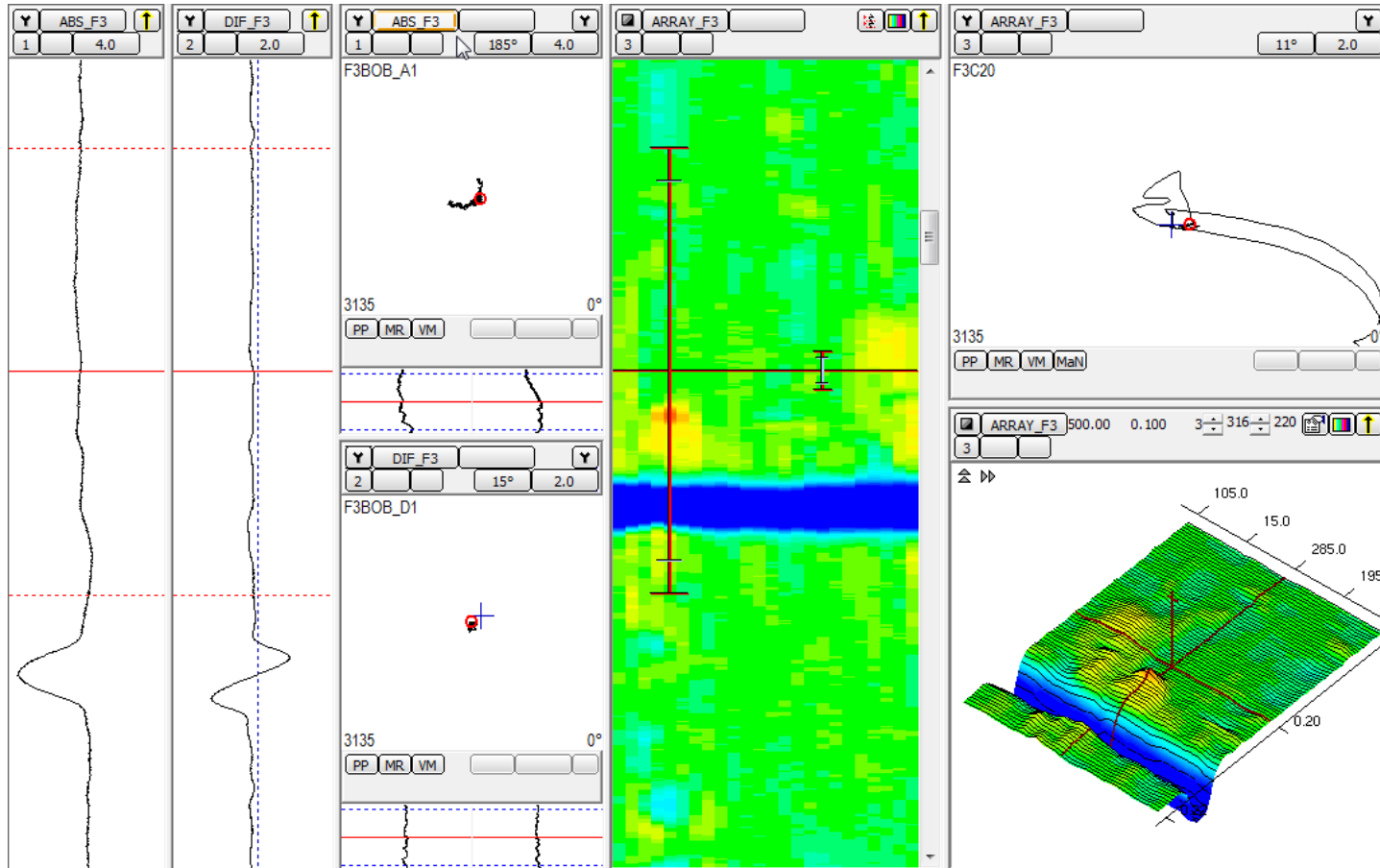



Data from real tube

- OD Isolated Pit / Corrosion – Field Tube

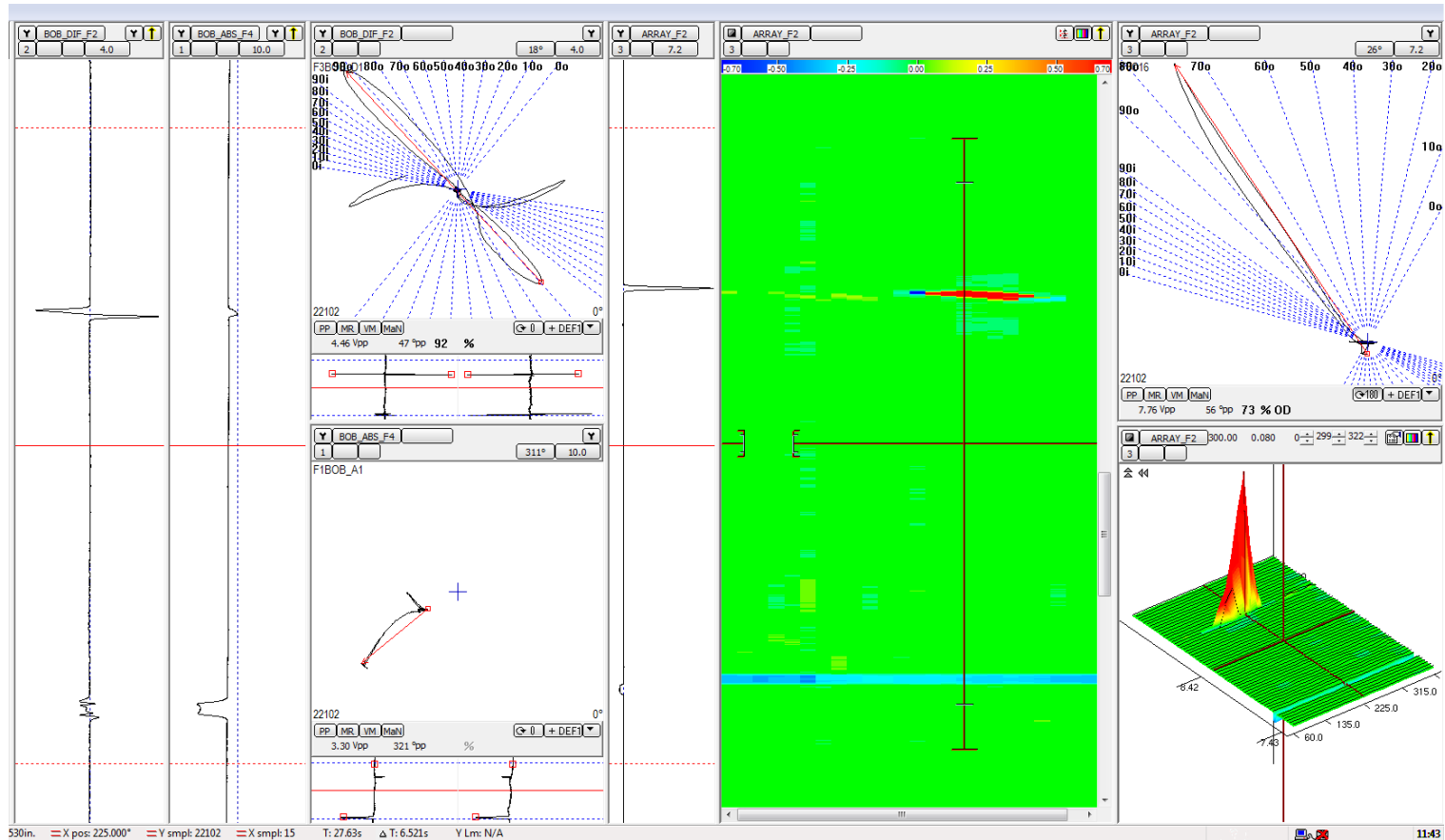



Conclusions

The DefHi eddy current array probe provides several benefits for non-ferrous tubing inspection:

- One-pass inspection providing bobbin and array probe signal
- High definition which provide reliable and repeatable detection of small defects whatever the position around the circumference
- High sensitivity to pitting and circumferential cracking (ID and OD circ. crack detected down to 20% depth and 25° extension)
- More reliable characterization of flaws with C-scan imaging
- Improved detection of circumferential cracking under tube sheets